

AIRCROSS3

User Manual

用户手册

Safety Caution 安全注意

- This product is powered by a built-in battery; please do not disassemble it, do not put it into liquid or fire in order to avoid damage or risk of injury.
- Before powering on the gimbal, please adjust the balance follow the instructions in this document. If the gimbal works in an unbalanced state for a long time, the surface temperature of the motor can get hot, which will seriously shorten the battery life.
- Do not let children touch and use this product, do not use fingers to obstruct the motor operation to avoid finger injury.
- This product is not waterproof or dustproof; please keep the gimbal clear of dust and water to avoid damage.
- 本产品内置电池，请勿私自拆卸，请勿投入液体或者火中，以免造成危险；
- 开机使用前请按照本文档的说明，调节好平衡，云台长时间工作在不平衡状态下将导致
- 电机表面温度较高，并且将会严重缩短续航时间；
- 请勿让儿童接触和使用本产品，请勿用手指阻碍电机运行，以免夹伤手指；
- 本产品不防水，不防尘，使用时请注意防水、防尘，以免造成损坏。



iOS



Android

Contents目录

EN	
MOZA AirCross 3 Overview	1
Preparation	2
Mounting the Camera	3
Balance Adjustment	4
Operation	5
Advanced Features	6
MOZA Master	9
Specifications	12
中文	
认识AirCross 3	13
准备	14
安装相机	15
调节平衡	16
开机使用	17
进阶使用	18
MOZA Master	21
规格参数	24
保修卡	25

MOZA AirCross 3 Overview

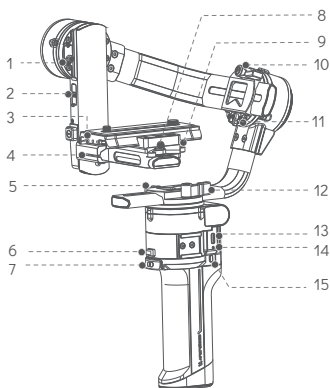

1. Tilt Motor Lock
2. Extension Port
3. Quick Release Plate
4. Tilt Adjustment Slider
5. Pan Motor Lock
6. Foldable Safety Lock
7. Smart Trigger
8. Quick Release Plate Knob
9. Quick Release Baseplate Knob
10. Roll Knob
11. Roll Motor Lock
12. Pan Knob
13. USB-C Charging Port
14. Battery Indicator Light
15. Power Button

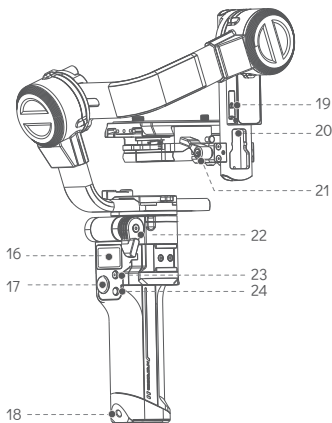

16. OLED Screen
17. Joystick
18. 1/4" Extension Port
19. Camera Control Port
20. AI Extension Port
21. Tilt Knob
22. Foldable Knob
23. Camera Control Button
24. Function Button

Preparation

Unfold the Gimbal

1. Rotate the foldable Knob;
2. Unfold the handle until it is locked.
3. Tighten the knob to prevent the handle from loosening.

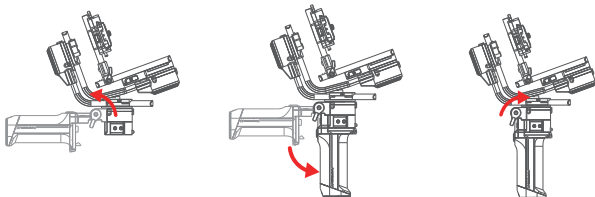

Attaching the Tripod

1. Screw the mini tripod into the screw hole at the bottom of the handle.
2. Expand the mini tripod

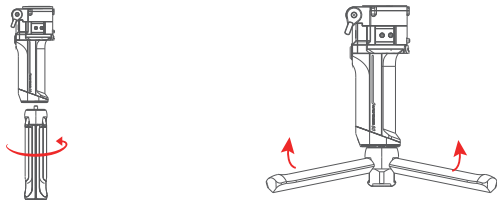

Battery Charging

Please charge the battery through the USB-C charging port using a USB-C cable (Included) and a USB adapter (Not included). It is recommended to use a USB adapter with QC2.0 or PD protocol to complete the charging quickly. The LED light below the charging port will switch off after the charging is completed.

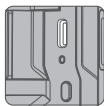

USB-C Port

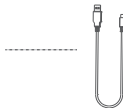

USB Type-C Cable

Unlock the Gimbal

Rotate the motor lock to the unlocked position, and then each motor can rotate freely.

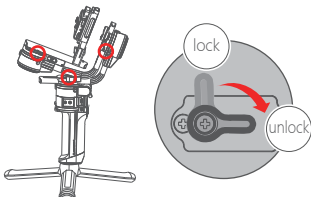

⚠ Note: Do not rotate the motor before unlocking, otherwise the motor lock may be damaged. If the gimbal is turned on before unlocking, the gimbal will enter sleep mode.

Mounting the Camera

Make sure to prepare the camera before mounting, confirm the battery is fully charged and a memory card with sufficient storage space is inserted.

1. Place the camera on the quick release plate with 1/4" or 3/8" screws and keep the camera in the center. Remove the extra screws as a spare.

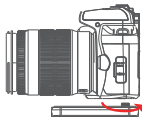

2. Slide the quick release plate onto the baseplate to the locked position.

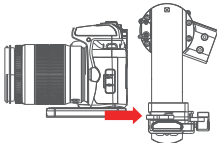

3. Secure the quick release plate and tighten the knob, make sure the quick release plate is locked.

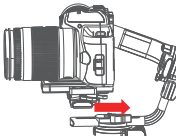

⚠ Note:

- a. When installing the camera, if the right side of the camera interferes with the tilt arm caused the installation to fail, loosen the knob of the quick-release baseplate and move it to the left until the camera can be installed successfully.
- b. After the camera is installed, move the quick-release baseplate to the right and make sure the camera's right side is aligned with the tilt arm to achieve the best stability.

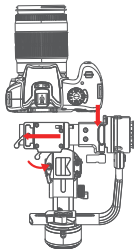

Balance Adjustment

1. Balancing the tilt axis vertical

- a. Rotate the camera so that the lens is pointing upward
- b. Unlock the tilt axis and loosen the knob, slightly adjust the position of the tilt adjustment slider.
- c. The balancing is completed when the camera is steady while pointing upward, lock the tilt axis.

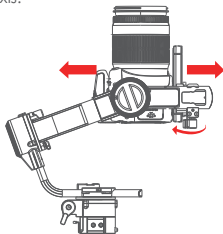

2. Balancing the tilt axis horizontal

- a. Rotate the camera so that the lens is pointing forward;
- b. Unlock the quick release plate, slightly adjust the position of the plate;
- c. The balancing is completed when the camera is steady while pointing forward, lock the quick release plate.

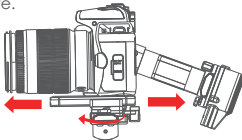

3. Balancing the Roll Axis

- Unlock the Roll axis.
- Slightly adjust the roll arm left and right until it's completely horizontal.
- Lock the roll axis.

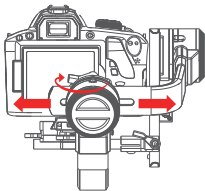

4. Balancing the Pan Axis

- Hold the gimbal at an angle of 45° horizontally, turn the pan arm to a horizontal angle.
- Unlock the Pan axis and slightly adjust the pan arm left and right.
- The Pan axis is balanced when the camera is steady, lock the pan axis.

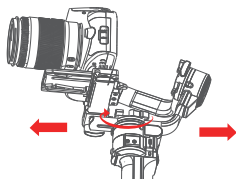

Operation



Power Button

Long Press: Power on or off

One Click: Switch the follow speed, 5 levels from slow to fast

Double-click: Enter or exit sleep mode.

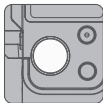

Joystick

Control the rotation of the gimbal

Menu:

Top Button: Option-up

Down Button: Option-down

Left Button: Return

Right Button: Confirm



Camera Control Button

Press halfway: Autofocus

One click: Start recording

Press and hold for 3 seconds: take a photo

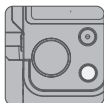

Function Button:

One Click: Follow mode (Pan→Pan&Tilt→FPV→All Lock)

Double Click: Sport Gear Mode

Triple Click: Inception Mode

Long Press: Enter/Exit Menu



Trigger Button

One Click: Start/Stop AI Follow Mode

Double Click: Re-center

Triple Click: Selfie Mode

Press and Hold: All Lock

One Click and Hold: Sport-Gear

Advanced Features

Display

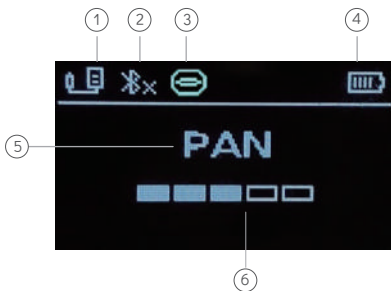

1. Camera Control Shutter JSB(Disconnected) USB(Connected)
2. Bluetooth Disconnected Connected
3. AI Module (Icon will display after the device is connected. If the device isn't connected no icon will be displayed.)
4. Battery Level
5. Follow Mode
6. Follow Speed

The follow mode and follow speed will not display after choosing the specific function, instead only the current function will be displayed. (Ex. Inception Mode, Time-lapse.)

MENU:

Camera	Set the connection type of the camera
Shutter	Set the connection type to universal shutter cable (Cable needs to be purchased separately.)
Multi	Set the connection type to Sony-Multi port
Multi/C	Set the connection type to Sony-Multi port with USB power supply
Remote	Set the connection type to Panasonic-Remote port (Cable needs to be purchased separately.)
USB	Set the connection type to universal USB port (Mini, micro, Type-C, etc)
Power	Set motor power
Autotune	Autotune set: the gimbal will set the appropriate motor power automatically
Manual	Manual set: each motor can be adjusted independently (levels 1-5)
Roll	Set roll motor power
Tilt	Set tilt motor power
Pan	Set pan motor power
Joystick	Set the control habit of the joystick
Sensitivity	Adjust the sensitivity; the higher the sensitivity, the faster the rotation speed of the gimbal.
Reverse	Reverse: the gimbal rotates in the opposite direction to the joystick operation.
Advanced	Advanced
Manual-Pos	Manual-Positioning (manually turn the gimbal to the specified direction and hold it for 2 seconds)
Open	Open the manual positioning
Close	Close the manual positioning
UART1	External communication port (AI port)
Open	Open the external communication port
Close	Close the external communication port
Calibrate	Calibrate the gimbal: automatically calibrate the sensor
Level	Level fine-tuning: forcibly adjust the camera's horizontal angle within $\pm 5^\circ$
System	System
Language	Set display language (Language selection will pop up automatically after the first boot or reset)
简体中文	Switch display language to simplified Chinese
English	Switch display language to English
Reset	Reset the gimbal: restore default parameter settings
About	Check Bluetooth name, hardware and firmware version

Auto Tuning

1. Unlock all the motors. Mount and balance the camera.
2. Attach the gimbal to a tripod. Place it on a level surface. Long press the power button to power on the gimbal.
3. Enter the Menu, then select Power then Autotune. Move the joystick to the right to select Autotune.
4. The motor will run automatically and gradually adjust the power of each motor. The gimbal will return to normal working status once the adjustment is completed. 工作状态。

Gimbal Calibration

1. Unlock all the motors. Mount and balance the camera.
2. Attach the gimbal to a tripod. Place it on a level surface. Long press the power button to power on the gimbal.
3. Enter the Menu, then select Advanced then Calibrate. Move the joystick to the right to select Calibrate.
4. The motor will automatically calibrate the sensor. Do not touch the gimbal during this process, just wait for the calibration to complete.

If the gimbal is placed on a tilt or shaky desktop then any shaking caused by touching the gimbal during this process will probably lead to failed calibration. You can try to calibrate again after making the necessary adjustments. Normally, calibration is only required if the gimbal is off tilt or drifting due to long-distance transportation, vibration, or intense temperature changes.

Level Fine-tuning

In some cases, the camera may not be fully horizontal due to installation and coordination differences between the camera and the gimbal. You will need to fine-tune the roll axis to make the camera completely horizontal.



1. Mount and balance the camera, unlock all the motors.
2. Attach the gimbal to a tripod. Place it on a level surface. Long press the power button to power on the gimbal.
3. Turn on the camera, and bring up the built-in digital level.
4. Enter the Menu, then select Advanced then Level. Move the joystick to the right to select Level to enter the fine-tuning interface.
5. Keep an eye on the digital level while moving the joystick up and down. Stop tuning when the digital level completely horizontal.

Reset And Restoration

If the gimbal can be powered on and off but is not operating smoothly, possibly due to abnormal parameters, you can enter the Menu and select About then select Reset to reset the parameters. The gimbal will automatically shut down after a reset, and it can be used normally after turning it on again. If the gimbal cannot be powered on or off normally, or cannot be started due to a firmware upgrade failure, you can use the ejection pin to press the internal restore hole to restore the parameters. Turn it on or try to upgrade the firmware again after restoration.

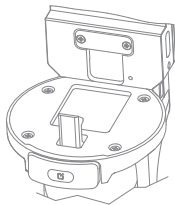

MOZA Master

Connection

1. Start MOZA Master and allow the permissions required by the App;
2. Choose the AirCross 3 in the device menu.
3. Click the “Connect” button behind the gimbal name;
4. Wait for the Bluetooth connection to complete.

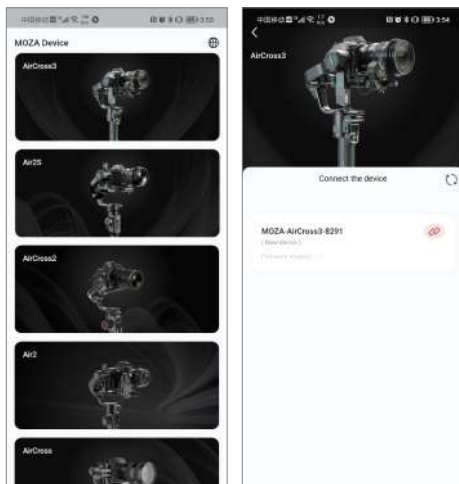

Main Interface

- ① Device Name
- ② Battery level (click to sleep/wake up the gimbal)
- ③ Camera Type (click to open up the camera list)
- ④ Remote Control (enter the remote control interface)
- ⑤ Settings (enter to set parameters)
- ⑥ Creative Videos (enter advanced functions such as time-lapse)
- ⑦ Inception (enter/exit Inception Mode)
- ⑧ Re-center (the gimbal returns to the starting position)
- ⑨ Disconnect Bluetooth Connection

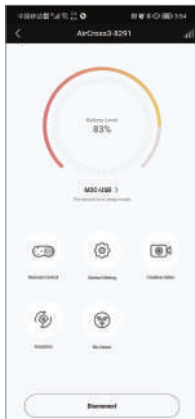

Remote Control

- ① Record/Stop (need to connect the camera control cable)
- ② Photo (need to connect the camera control cable)
- ③ Selfie (after clicking, the gimbal pan axis will rotate 180°)
- ④ Virtual Joystick (control the tilt and pan rotation of the gimbal)
- ⑤ Remote Control Speed (Set the gimbal rotation speed controlled by the virtual joystick.)
- ⑥ Re-centering (the gimbal returns to the starting position)

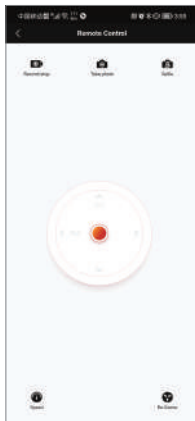

Gimbal Setting

- ① Motor setting, set the motor power, autotune, follow speed, follow modes, etc.
- ② Joystick definition , set the sensitivity and operating habits of the joystick.
- ③ Advanced setting, sensor calibration, level fine-tuning, firmware upgrade, etc.
- ④ About, check the firmware version and APP version.



Firmware Upgrade

After the MOZA Master app is connected to the gimbal, enter the Menu and select Gimbal Setting then Advanced Setting then Upgrade. If there is a new firmware update, clicking the Confirm button will start the upgrade process. The upgrade process takes time, please be patient. Once the upgrade is finished, the gimbal will automatically turn off and it can be used again after powering it back on.

Do not turn off the gimbal, or turn off the mobile phones Bluetooth, or disconnect the mobile phones network or exit MOZA Master during the upgrade process. Doing any of these might lead to an upgrade failure.

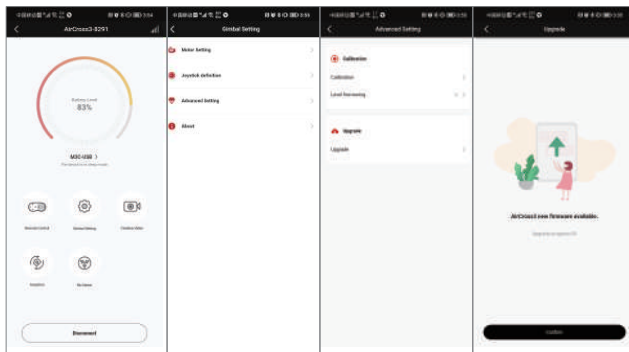

Specifications

Model: AirCross 3

Weight: 1.3kg without tripod

Dimension: Unfold: 170*190*310mm,
(W*D*H) folded: 52*225*270mm

Battery Type: Li-ion Intelligent Battery(built-in), 25.45Wh

Battery Capacity: 3500mAh

Standard Voltage: 7.27V

Charging Voltage: 5V/2A, 9V/2A

Working hours: 20H

Fast-charging time: 1.4H

Bluetooth: BT5.0, 2.400 GHz -2.4835 GHz

Environmental Working temperature: -10 °C -50 °C;
requirements: Charging temperature: 5 °C -40 °C

认识AirCross 3

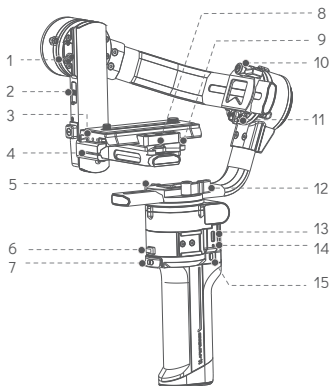

1. 俯仰电机锁
2. 外设扩展接口
3. 快装板
4. 俯仰调节滑块
5. 航向电机锁
6. 折叠安全锁扣
7. 扳机键
8. 快装板锁紧扳手
9. 快装板底座缩紧扳手
10. 横滚臂锁紧旋钮
11. 横滚电机锁
12. 航向臂锁紧旋钮
13. USB-C充电接口
14. 充电指示灯
15. 电源键

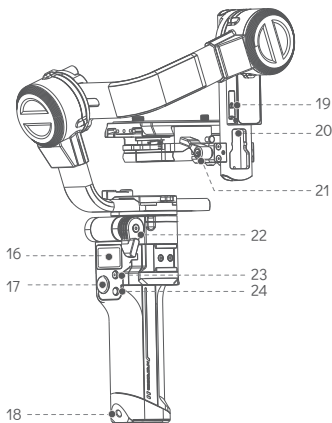

16. OLED显示屏
17. 摇杆
18. 1/4" 螺丝孔
19. 相机控制接口
20. AI拓展接口
21. 俯仰臂锁紧旋钮
22. 折叠锁紧旋钮
23. 相机控制键
24. 功能键

准备

展开云台

1. 折叠锁紧旋钮；
2. 将手柄折回到竖直位置，直到折叠安全锁扣已经锁住手柄；
3. 锁紧折叠锁紧旋钮，防止手柄松动。

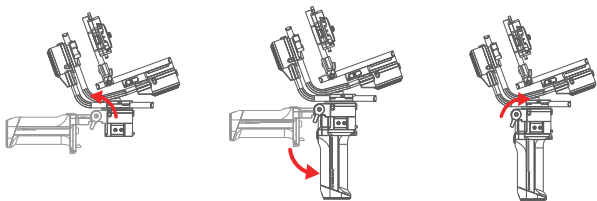

安装三脚架

1. 将三脚架拧入手柄底部的螺丝孔中
2. 展开三脚架的支撑脚。

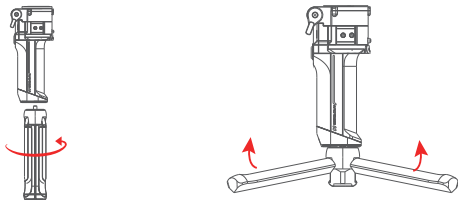

充电

请自备USB充电器，通过包装内含的USB-C线缆，连接到OLED屏幕左侧的USB-C接口上，给云台充电。推荐使用满足QC2.0或PD协议的USB充电器，能够快速完成充电，充电完成后，充电接口下方的LED灯会熄灭。

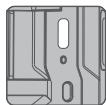

USB-C接口



USB充电线

解锁

将电机锁旋转至解锁位置，各个电机即可自由转动。

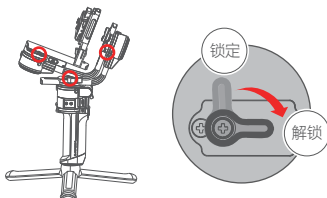

⚠ 注意：切勿在未解锁前暴力转动电机，否则可能造成电机锁损坏。如果未解锁前进行开机，云台会进入休眠状态。

安装相机

安装相机前，请确保相机已经装入电量充足的电池和存储空间足够的存储卡，确保相机已经准备好拍摄工作。

1. 将相机通过1/4" 或者3/8" 螺丝固定到快装板上，相机重量分布尽量均匀，多余的螺丝可取下备用；

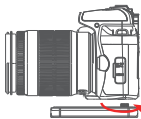

2. 将快装板滑入快装底座中，直到安全销卡住快装板；

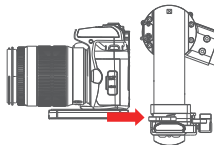

3. 锁紧快装板锁紧扳手，确认快装板无法滑动；没有锁紧时，可往复扳手多次锁紧。

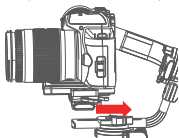

注意：

- a. 若装入相机时，相机右侧与俯仰臂干涉无法安装，可松开快装底座锁紧扳手，将快装底座向左侧移动，直到相机能顺利安装；
- b. 安装好相机后，请将快装底座尽量向右移动，使相机右侧靠齐俯仰臂，以达到最佳的系统稳定性。

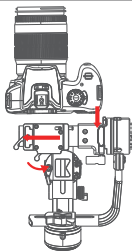

调节平衡

1. 上下：

- a. 将相机转动到镜头朝上；
- b. 松开俯仰臂锁紧旋钮，轻微调节俯仰臂锁紧滑块的位置；
- c. 当镜头能保持向上，不再转动后，调节完毕，锁紧俯仰臂锁紧旋钮。

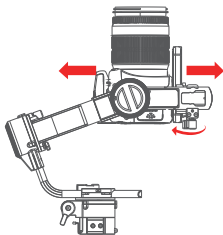

2. 左右：

- a. 将相机转动到镜头朝前；
- b. 松开快装板锁紧扳手，轻微调节快装板的位置；
- c. 当镜头能保持向前，不再转动后，调节完毕，锁紧快装板锁紧扳手。

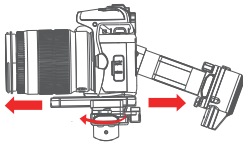

3. 横滚:

- 松开横滚臂锁紧旋钮;
- 左右微调横滚臂, 直到横滚臂完全水平, 不偏向一侧;
- 锁紧横滚臂锁紧旋钮。

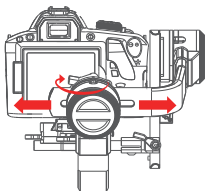

4 航向:

- 倾斜45°握持云台, 将航向臂转动到水平角度;
- 松开航向臂锁紧旋钮, 左右微调航向臂;
- 当航向臂能保持水平, 调节完成, 锁紧航向臂锁紧旋钮。

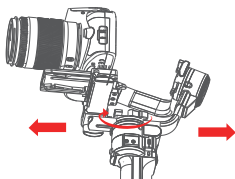

开机使用



电源键:

长按: 开机、关机

单击: 切换跟随速度, 从慢到快5个级别

双击: 休眠、唤醒

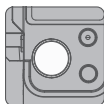

摇杆:

主界面: 控制云台转动

菜单界面:

上: 选择条上移

下: 选择条下移

左: 返回

右: 确认

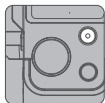

拍摄键:

半按: 对焦

全按: 录制

全按3秒: 拍照



功能键:

单击: 切换跟随模式

(航向跟随、航向-俯仰跟随、全跟随、全锁定)

双击: 急速跟随, 能提供最大的转向跟随速度

三击: 盗梦空间, 可拍摄360°旋转的画面

长按: 进入、退出菜单



扳机键:

单击: 开始、停止AI跟随 (需连接AI跟踪模块)

双击: 归中

三击: 自拍

按住: 全锁定

单击按住: 急速跟随

进阶使用

屏幕显示

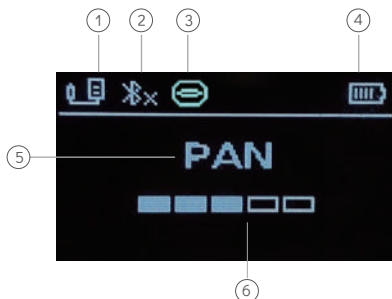

1. 相机控制模式 快门模式 USB (未连接) USB (已连接)

2. 蓝牙状态 未连接 已连接

3. AI模块 (连接并启动后出现) 4. 电池电量

5. 跟随模式

6. 跟随速度

在进入特殊功能后, 跟随模式和跟随速度不再显示, 而是显示当前的功能模式 (如盗梦空间、延时摄影等)。

菜单功能

相机	设定相机所使用的控制方式
快门线	通用快门线控制（线材需额外购买）
Multi	索尼Multi接口控制
Multi/C	具有USB供电能力的索尼Multi接口控制
Remote	适用于松下相机REMOTE接口控制（线材需额外购买）
USB	通用的USB接口控制（Mini、Micro、Type-C等接口）
负载	设定电机的出力大小
自适应	自动调节，云台会自行寻找合适的出力大小
手动	手动调节，每个电机都能独立调节（1-5档）
横滚	横滚电机力度
俯仰	俯仰电机力度
航向	航向电机力度
摇杆	设定摇杆的使用习惯
灵敏度	调节灵敏度，灵敏度越高，则控制云台转动的速度越快
反向	反向，云台转动方向与摇杆操作方向相反
高级	高级功能
手动定位	手动定位（手动将云台掰向指定方向后保持2秒）
打开	启动手动定位功能
关闭	关闭手动定位功能
UART1	外部通讯口（AI接口）
打开	启动外部通讯口
关闭	关闭外部通讯口
云台校准	自动校准传感器
水平微调	可以 $\pm 5^\circ$ 内强制调节相机的水平状态
系统	系统设置
语言	语言设置（首次开机或重置后，会自动弹出语言选择）
简体中文	显示语言设置为简体中文
English	显示语言设置为英文
恢复	重置稳定器，所有参数回复为出厂设定
关于	查看系统蓝牙名称、硬件以及固件版本

自动调参

1. 安装好相机并调节好平衡，解开所有的电机锁；
2. 将稳定器装好三脚架，放置在平稳的地方，长按电源键开机；
3. 进入菜单，选择‘负载>自适应’，右拨摇杆；
4. 稳定器电机机会自动运行，逐步调节各个电机的力度，调节完成后回到正常工作状态。

校准云台

1. 安装好相机并调节好平衡，解开所有的电机锁；
 2. 将稳定器装好三脚架，放置在平稳无晃动的地方，长按电源键开机；
 3. 进入菜单，选择‘高级>云台校准’，右拨摇杆；
 4. 稳定器电机机会自动校准传感器，校准过程中请勿触碰稳定器，等待校准完成即可。
- 稳定器歪斜放置或放置的桌面有明显晃动、校准过程中触碰导致稳定器晃动等都可能可能会导致校准失败，调整好后再次尝试校准即可。一般情况下无需校准，长途运输振动或强烈温度变化导致稳定器歪斜、漂移时，才需要进行校准。

水平微调

由于相机与本稳定器之间的安装配合存在差异，在某些情况下，相机不能达到完全水平，需要微调横滚轴使相机完全水平。



1. 安装好相机并调节好平衡，解开所有的电机锁；
2. 将稳定器装好三脚架，放置在平稳无晃动的地方，长按电源键开机；
3. 开启相机，并调出相机的内置水平仪；
4. 进入菜单，选择‘高级>水平微调’，右拨摇杆，进入微调界面；
5. 上拨或下拨摇杆，并观察相机的水平仪，待相机水平仪完全水平即可停止调节。

重置和复位

如果稳定器能够开关机，但因参数异常导致操作不顺畅，可进入菜单，选择‘关于>恢复’来重置稳定器参数。稳定器重置后会自动关机，重新开启即可正常使用。

如果稳定器无法正常开关机，或者因固件升级失败导致无法启动，可以使用取卡针按压内部的复位孔，来复位稳定器。复位后再次开机或者升级固件即可。

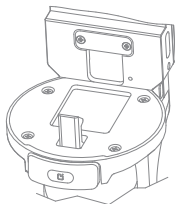

MOZA Master

连接

- 1.启动MOZA Master，允许APP获得所需要的权限；
- 2.进入设备卡片，选择AirCross 3；
- 3.在搜索到设备中，找到需要连接的稳定器，点击名称后面的连接按钮；
- 4.等待蓝牙完成连接即可。

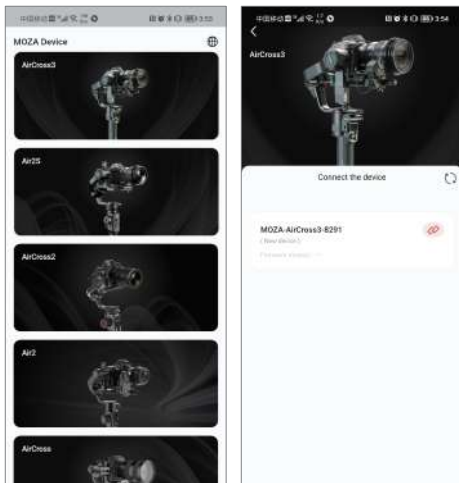

主界面

- ①设备名称
- ②电池电量（单击可休眠/唤醒稳定器）
- ③相机类型（单击弹出相机选择列表）
- ④遥控按钮（进入遥控界面）
- ⑤设置按钮（进入参数设置）
- ⑥创意影视（进入延时摄影等高级功能）
- ⑦Inception（进入/退出盗梦空间模式）
- ⑧归中按钮（稳定器回到起始位置）
- ⑨断开蓝牙连接

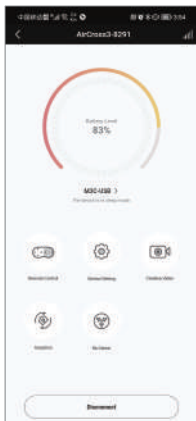

遥控

- ①录制/停止按钮（需连接好相机控制线）
- ②拍照按钮（需连接好相机控制线）
- ③自拍（点击后稳定器航向转动180°）
- ④虚拟摇杆（控制稳定器俯仰和航向转动）
- ⑤遥控速度（设置虚拟摇杆控制稳定器转动的速度）
- ⑥归中按钮稳定器回到起始位置）

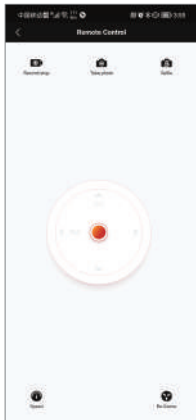

参数设置

- ①电机参数，设置电机力度、自动调参、跟随速度、跟随模式等。
- ②摇杆定义，设置摇杆的灵敏度、操作习惯等。
- ③高级设置，传感器校准、水平微调、固件升级等。
- ④关于，查看稳定器固件版本及APP版本。



固件升级

MOZA Master连接好稳定器后，进入‘云台设置>高级设置>升级’，如有新的固件可升级，点击‘确定’按钮即可。升级过程较为缓慢，请耐心等待。升级完成后，稳定器会自动关机，重新开机即可使用。

升级过程中请勿关闭稳定器，请勿关闭手机蓝牙、断开手机网络或退出MOZA Master，否则可能导致升级失败。

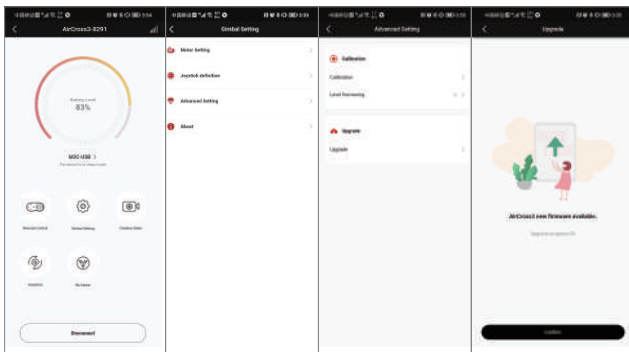

规格参数

型号: AirCross 3

重量: 1.3Kg (不含三脚架)

尺寸: 完全展开约为170*190*310 mm

折叠后约为52*225*270mm

电池类型: 内置智能电池, 25.45Wh

电池容量: 3500mAh

标称电压: 7.27V

充电电压: 5V/2A、9V/2A

最长续航时间: 20H

最快充电时间: 1.4H

蓝牙: BT5.0, 2.400 GHz -2.4835 GHz

环境要求: 工作温度: -10°C--50°C

充电温度: 5°C--40°C

产品保修卡

用户资料

产品型号	MOZA AirCross 3
购买日期	
姓 名	
电 话	
地 址	

经销商信息 (签章)

产品保修条例

保修期

自购机日起, 云台主体保修12个月; 云台电机、电池保修3个月。设备外壳、说明书、USB线材、包装等不在"一年免费保修服务"范围内, 您可以选择有偿服务。

七日内免费退货

自购机日起7日内, 根据国家最新三包规定, 您可以选择退货 (按票面金额一次性退清货款)、换货 (更换同型号同规格的产品) 或修理。

八至十五日免费换货或修理

自购机日起第8日至第15日内, 主机出现性能故障, 并经特约维修中心检测, 确认非人为损坏的本身质量问题, 您可以选择换货(更换同型号、同规格产品)或修理; 但是更换的范围, 只限于产品主机, 其他配件无质量问题, 不能更换; 购买者在以下条件下不享受免费保修服务, 您可以选择有偿服务。

1. 超过三包有效期的;
2. 无三包凭证及有效发货票的, 但能够证明该产品在三包有效期内的除外;
3. 包修凭证上的型号与修理产品型号不符或者涂改的;
4. 非本公司特约维修人员拆卸造成损坏的;
5. 因不可抗力造成损坏的;
6. 未按产品使用说明书要求使用、维护、保养而造成损坏的。



Follow us
魔爪社交媒体



MOZA WeChat
魔爪微信公众号

GUDSEN

INVENTED FOR VIDEO

Shenzhen Gudsen Technology Co., Ltd

Web: www.gudsen.com